

Prislista

Arbetsstolar
Adda



Valid from 1 March 2025

profim

Contents

Order entry specifications

Profim ACCIS PRO     

Profim LIGHT UP     

Profim MOTTO    

Profim PACE     

Profim TRILLO PRO     

Profim VIOLLE     

Technical details

Packaging - swivel chair

Technical details

Fabrics and finishings

Profim Standard fabrics Fabrics

and finishings - Extended Legend

ORDER ENTRY SPECIFICATIONS

When placing your order please remember to specify the following information:

- All configuration details of products
- Required delivery/dispatch date
- Required delivery address

Binding sales agreement for the ordered products is concluded by formal order confirmation sent by Flokk.

Flokk sales conditions override any individual customer's general terms& conditions or regulations.

PRICES

All prices in SEK exclusive of VAT. Valid from 01/03/2025 Any typographical errors shall not be binding for Flokk and will be subject to correction without liability to the vendor.

CONDITIONS OF DELIVERY

Ex Works (Incoterms 2020), including packaging. Visible transport damage and discrepancies in the number of items received must always be noted on the bill of carriage at the time of receipt and reported to the carrier. Invisible transport damage (damaged product, but not package) should be reported in writing to Customer Service or Claim Department Flokk within 7 days.

In case of delays in ready products collection storage fees will apply, details available at Customer Service.

CHANGE/CANCELLATION OF ORDERS

Any requests for change or cancellation of the order must be submitted within 2 working days after the receipt of the order confirmation.

After this time each amended or cancelled order will incur a charge of 500 SEK order. Once production has started orders cannot be changed.

NON-STANDARD PRODUCTS

Non-standard products not available in this pricelist could be proceed with quantities starting from 5 pcs and will be priced individually.

It may be possible to offer products in customer own fabrics, but the fabric would have to be tested. Cost of the test is 500 SEK for swivel and conference chair and 100 eur for soft seating, this price refers to each tested model/version of the product.

Product	standard: 1 10-20 working days	extended: 30 working days
Task chairs	10-20 working days	-

Longer delivery times may occur periodically, during holidays and for especially large orders.

Swivel chairs

Profim ACCIS PRO

ITO Design

- Innovative system of independent side-to-side movement of both backrest and seat (SmarrHPS)
- Easy adjustment of the basic functions of the mechanism ensuring synchronised tilt of the backrest and seat
- Adjustable armrests, lumbar support and seat extension
- For safety reasons, the gaps between moving parts are no more than 5 mm and where this was not possible special covers were used
- Blue Angel certificate - confirms that our chair is environmentally friendly

Item no	Base model +	Price Group (PG)	Price Group						Price
			0	①	②	③	④	⑤	
MAT150SF00	Profim ACCIS PRO 150SFL • swivel • mesh backrest • Synchro mechanism, sliding seat, seat forward tilt • seat side-movement function • base: black • armrests: P63TPU • gaslift with shock (gaslift cover - always in base colour)		7 354	7 566	7 799	8 110	8 442	8 391	9 365

MAT151SF00	Profim ACCIS PRO 151SFL • swivel • mesh backrest • Synchro mechanism, sliding seat, seat forward tilt • seat side-movement function • base: black • armrests: P63TPU • gaslift with shock (gaslift cover - always in base colour) • headrest		8 404	8 638	8 884	9 240	9 612	9 464	10 441
------------	--	--	-------	-------	-------	-------	-------	-------	--------

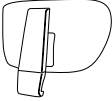
MAT0010000	Profim ACCIS PRO 001 Headrest (001) - height and angle adjustment (rear part of headrest black or light grey)		1 061	1 061	1 061	1 061	1 061	1 061	1 061
------------	--	---	-------	-------	-------	-------	-------	-------	-------

Accessories/Options/Surcharges:

7BASC006	Base: lightgray - base color (Only for: 150SFL, 151SFL)	851
7BASC002	Base: white - base color (Only for: 150SFL, 151SFL)	1 296
7BASC005	Base: graphite - base color (Only for: 150SFL, 151SFL)	679
7BASC003	Base: polished aluminum - base color (Only for: 150SFL, 151SFL)	679
7LUSU003	Lumbar support TYPE B - height and depth adjustable - lumbar support TYPE B - height and depth adjustable (Only for: 150SFL, 151SFL)	346

0 price group: Alba, Evo, Next,

1 price group: Cura, Tonal, Xtreme

2 price group: Select

3 price group: Capture, Oceanic, Step, Synergy

4 price group: Steelcut 3, Steelcut Trio 3

Castors/glides:

- hard castors - for soft floors (set),
- soft castors - for hard floors (set),
- teflon glides - universal (set).

When ordering please clearly indicate the chosen option.

Armrest P63TPU - height adjustable armrest (range 100 mm), sliding pad (+/- 50 mm) with span option (+/- 27 mm), and pivot option (+/- 27°), polyurethane pad.

Armrest colour:

- black - used with base: black, graphite, polished aluminum
- lightgrey - used with base: lightgrey, white.

It is no possible to purchase the chair in version without armrests.

Plastic colours:

- bases: black / graphite / polished aluminium,
- plastics always black,
- bases: lightgrey / white - plastics always lightgrey.

Plastic elements: seat cover + adjustments levers, armrests, backrest frame, rear part of headrest, lumbar support, castors.

AccisPro can be upholstered in Runner or Rhythm mesh. When ordering please clearly indicate the chosen option.

Seat covers can be made also for Rhythm and Runner upholstery.

In the 150SFL model it is possible to buy a headrest (001) for self-assembly. The headrest can be made in the seat upholstery or in Runner or Rhythm meshes. When ordering, please clearly indicate the chosen option. The price does not change.



Armrest P48PU - height adjustable armrest (range 100 mm) , sliding pad (range +/- 30 mm) with pivot option (30° on each side), polyurethane pad.
Armrests P48PU are always black.

Type of backrest mesh: GZ.
Irrespective of the type of the backrest, headrest is always mesh upholstered.

Lumbar support element always upholstered in black Softline (SL-18).
Models with backrest upholstered in leather - rear part of back always covered with black fabric STEP (code 60999).

Quilting - extra charge to all price groups, lead time 30-40 working days.







Action can be used by persons weighing up to 150 kg.

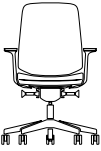
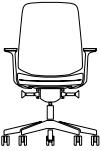
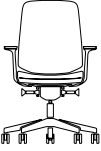

Profim LIGHT UP

ITO Design

- The backrest comes in two variants: mesh and upholstered
- Two colours of the plastic finish and 3 colours of the base open up design possibilities
- Available as a hocker with footrest
- Option with jacket hanger
- Consists of a very small number of components and is 95% recyclable
- Blue Angel certificate - confirms that our chair is environmentally friendly
- Möbelfakta certificate - a guarantee of durability, safety, environmental care and social responsibility during the production process

Item no	Base model +	Price Group (PG)	0	①	②	③	④	⑤	Price
MLY300S000	Profim LIGHT UP 230S <ul style="list-style-type: none"> • upholstered backrest • Synchro mechanism • base: black • non-arm version 		3 233	3 541	3 740	3 891	4 960	4 339	
MLY300SL00	Profim LIGHT UP 230SL <ul style="list-style-type: none"> • upholstered backrest • Synchro mechanism, sliding seat • base: black • non-arm version 		3 480	3 788	3 986	4 146	5 208	4 624	
MLY300SF00	Profim LIGHT UP 230SFL <ul style="list-style-type: none"> • upholstered backrest • Synchro mechanism, sliding seat • seat and backrest forward tilt • base: black • non-arm version 		3 640	3 948	4 134	4 300	5 368	4 796	
MLY500S000	Profim LIGHT UP 250S <ul style="list-style-type: none"> • mesh backrest • Synchro mechanism • base: black • non-arm version 		3 147	3 319	3 469	3 606	3 986	4 023	
MLY500SL00	Profim LIGHT UP 250SL <ul style="list-style-type: none"> • mesh backrest • Synchro mechanism • sliding seat • base: black • non-arm version 		3 394	3 541	3 715	3 863	4 232	4 308	
MLY500SF00	Profim LIGHT UP 250SFL <ul style="list-style-type: none"> • mesh backrest • Synchro mechanism • sliding seat • seat and backrest forward tilt • base: black • non-arm version 		3 541	3 715	3 875	4 030	4 382	4 495	

Item no	Base model +	Price Group (PG)	0	①	②	③	④	⑤	Price
MLY330S000	Profim LIGHT UP 330S • hocker with footrest • upholstered backrest • Synchro mechanism • base: black • non-arm version		4 429	4 762	4 936	5 134	6 169	5 727	

MLY350S000	Profim LIGHT UP 350S • hocker with footrest • mesh backrest • Synchro mechanism • base: black • non-arm version		4 332	4 492	4 640	4 826	5 159	5 382	
------------	--	---	-------	-------	-------	-------	-------	-------	--

Accessories/Options/Surcharges:

7BASC006	Base: lightgray (Only for: 230SL, 230SFL, 250SL, 250SFL)	679
7BASC003	Base: polished aluminum	679
7ARMR033	Armrests P67TPU Black (set)	556
7ARMR034	Armrests P67TPU - light grey (set) (Only for: 230SFL, 230SL, 250SFL, 250SL)	692
7ARMR035	Armrests P68TPU - black (set)	803
7LUSU004	Lumbar support TYPE A - height adjustable	111
7LUSU003	Lumbar support TYPE B - height and depth adjustable	210
7TGAS005	Gas lift with shock absorber - black or lightgrey, gas lift cover always in base colour (Only for: 230S, 230SL, 230SFL, 250S, 250SL, 250SFL)	346
7HANG002	Clothes hanger (HA), black or light grey, maximum load 4 kg.	333
7SEQU004	Quilting - front side of the seat (Q1)	456

0 price group: Alba, Evo, Next

1 price group: Cura, Tonal, Xtreme

2 price group: Select

3 price group: Capture, Oceanic, Step, Synergy

4 price group: Steelcut 3, Steelcut Trio 3

Castors/glides:

- hard castors - for soft floors (set),
- soft castors - for hard floors (set),
- teflon glides - universal (set).

When ordering please clearly indicate the chosen option.

While ordering LightUp 230SL / 230SFL with light grey base all plastic elements (seat cover, backrest frame, lumbar support, armrests, hanger) will be light grey as well.

P67TPU – height adjustable (range 100 mm), soft termo polyurethane (TPU) pad.

P68TPU – height adjustable (range 100 mm), sliding pad adjustment (range 50 mm), with span option (range 27 mm), swivel pad adjustment (range 33°), soft termo polyurethane (TPU) pad.

Armrest colour:

- black - used with base: black, chrome (polished aluminum) (for armrest P67TPU and P68TPU),
- light grey - used with base: light grey, white (for armrest P67TPU).

In LightUp 330S /350S castors are equipped with reverse brake, which enable chair from moving away while seated.

Types of mesh: Runner, String. When ordering please clearly indicate the chosen option.

Quilting - extra charge to all price groups, lead time 30-40 working days.

* only models with mesh backrest



www.blauer-engel.de/uz117

Profim MOTTO

- Wide range of colours and finishing fabrics
- Backrests tilting in any direction
- Adjustable armrests and headrest
- Collection is completed with two versions of conference chairs (with low and high backrest)
- Blue Angel certificate - confirms that our chair is environmentally friendly
- Möbelfakta certificate - a guarantee of durability, safety, environmental care and social responsibility during the production process

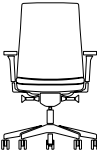
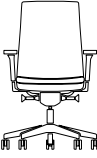
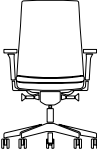
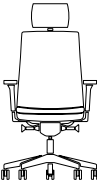
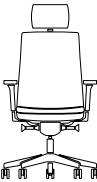
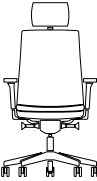
Item no	Base model +	Price Group (PG)	0	①	②	③	④	⑤	Price
MMO100S000	Profim MOTTO 10S <ul style="list-style-type: none"> • fully upholstered backrest • Synchro mechanism • base: black • non-arm version 		3 602	4 010	4 270	4 441	5 690	4 954	
MMO100SL00	Profim MOTTO 10SL <ul style="list-style-type: none"> • fully upholstered backrest • Synchro mechanism • sliding seat • base: black • non-arm version 		3 838	4 246	4 516	4 697	5 936	5 239	
MMO100SF00	Profim MOTTO 10SFL <ul style="list-style-type: none"> • fully upholstered backrest • Synchro mechanism • sliding seat • seat and backrest forward tilt • base: black • non-arm version 		4 010	4 405	4 665	4 851	6 084	5 411	
MMO110S000	Profim MOTTO 11S <ul style="list-style-type: none"> • high backrest • Synchro mechanism • base: black • non-arm version • headrest 		4 665	5 072	5 332	5 545	7 070	6 185	
MMO110SL00	Profim MOTTO 11SL <ul style="list-style-type: none"> • high backrest • Synchro mechanism • sliding seat • base: black • non-arm version • headrest 		4 912	5 319	5 565	5 787	7 317	6 454	
MMO110SF00	Profim MOTTO 11SFL <ul style="list-style-type: none"> • high backrest • Synchro mechanism • sliding seat • seat and backrest forward tilt • base: black • non-arm version • headrest 		5 072	5 466	5 726	5 954	7 465	6 642	

Accessories/Options/Surcharges:

7BASC003	Base: polished aluminum	766
7ARMR033	Armrests P67TPU Black (set)	556
7ARMR035	Armrests P68TPU - black (set)	803
7LUSU002	Lumbar support - depth adjustable - depth adjustment (schukra)	333
7TGAS005	Gas lift with shock absorber	246
7TGAS003	Gas lift with memory	761
7SBQU005	Quilting - front side of the seat (Q1)	456
7SBQU006	Quilting - front of the backrest (Q2)	519

0 price group: Alba, Evo, Next

1 price group: Cura, Tonal, Xtreme

2 price group: Select

3 price group: Capture, Oceanic, Step, Synergy

4 price group: Steelcut 3, Steelcut Trio 3

Castors/glides:

- hard castors - for soft floors (set),
- soft castors - for hard floors (set),
- teflon glides - universal (set).

Glides in Motto 10F/20F:

- standard - teflon glides (universal),
- option - felt glides (for hard floors).

When ordering please clearly indicate the chosen option.

P67TPU – height adjustable (range 100 mm), soft termo polyurethane (TPU) pad.

P68TPU – height adjustable (range 100 mm), sliding pad adjustment (range 50 mm), with span option (range 27 mm), swivel pad adjustment (range 33°), soft termo polyurethane (TPU) pad.

The connector of the backrest with the seat is always black, irrespective of the colour of base.

The connector of the backrest with the seat is always black, irrespective of the colour of base.

Option of mixing two colours of the same fabric according to below scheme:

A - front of seat and backrest, B - sides of seat, rear part and sides of backrest

In case of order of such option, following example should be specified: SC-67097/SC-60132 (gdzie SC-67097 - A, SC-60132 - B). Option is available at no extra charge.



Quilting - extra charge to all price groups, lead time 30-40 working days.



Profim PACE

- Patented Synchro SFL MAX mechanism with synchronized backrest and seat adjustment, plus additional features such as seat depth adjustment and forward tilt for enhanced comfort.
- Innovative second-generation lumbar support adjustment – SmartADLS (available in the 150SFL MAX, 151SFL MAX models), which adapts the geometry of the entire backrest to support the spine's natural S-curve.
- Convenient backrest resistance adjustment with a single turn of a knob allows for quick customization of the chair to the user's weight and preferences, ensuring optimal support during work.
- Pace is partially made from recycled and recyclable materials, designed without the use of staples or glue for easier disassembly and sustainability.

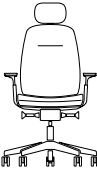
ITO Design

Item no	Base model +	Price Group (PG)	Price Group						Price
			0	①	②	③	④	⑤	
MNN100SF00	Profim Pace 100SFL MAX <ul style="list-style-type: none"> • upholstered backrest • Synchro mechanism, sliding seat, seat forward tilt • base: black • select additionally one of two types of armrests • no version without armrests, 		5 068	5 282	5 335	5 548	5 815	6 189	7 149
MNN101SF00	Profim Pace 101SFL MAX <ul style="list-style-type: none"> • upholstered backrest • Synchro mechanism, sliding seat, seat forward tilt • base: black • select additionally one of two types of armrests • no version without armrests, • headrest 		5 439	5 668	5 725	5 954	6 240	6 641	7 672
MNN150SF00	Profim Pace 150SFL MAX <ul style="list-style-type: none"> • mesh backrest • Synchro mechanism, sliding seat, seat forward tilt • Innovative lumbar support with depth adjustment (changing backrest curvature) SmartADLS • base: black • select additionally one of two types of armrests • no version without armrests, 		4 973	5 183	5 235	5 444	5 706	6 073	7 015
MNN151SF00	Profim Pace 151SFL MAX <ul style="list-style-type: none"> • mesh backrest • Synchro mechanism, sliding seat, seat forward tilt • Innovative lumbar support with depth adjustment (changing backrest curvature) SmartADLS • base: black • select additionally one of two types of armrests • no version without armrests, • headrest 		5 344	5 569	5 625	5 850	6 131	6 525	7 538

Accessories/Options/Surcharges:

7HANG002	Clothes hanger	154
7LUSU003	Lumbar support TYPE B - height and depth adjustable (Only for: 100SFL MAX, 101SFL MAX)	339
7LUSU003	Lumbar support TYPE B - height and depth adjustable (Only for: 150SFL MAX, 151SFL MAX)	431
7ARMR025	Armrests P65TPU (set)	755
7ARMR027	Armrests P66TPU (set)	1 079
7TGAS005	Gas lift with shock absorber	308

Accessories/Options/Surcharges:

7BASC006	Base: lightgray (Only for: 100SFL MAX, 101SFL MAX)	657
7BASC006	Base: lightgray (Only for: 150SFL MAX, 151SFL MAX)	1 314
7BASC015	Base: polished aluminum	894

0 price group: Alba, Evo, Next

1 price group: Cura, Medley, Tonal, Valencia*, Xtreme

2 price group: Select

3 price group: Capture, Oceanic, Step, Synergy

4 price group: Steelcut 3, Steelcut Trio 3

5 price group: Leather

6 price group: Leather Premium

Castors/glides:

- hard castors - for soft floors (set),
- soft castors - for hard floors (set),
- teflon glides - universal (set).

When ordering please clearly indicate the chosen option.

While ordering Pace 100SFL MAX / 101SFL MAX / 150SFL MAX/ 151SFL MAX with light grey base all plastic elements (seat cover, backrest frame, lumbar support, armrests, hanger) will be light grey as well.

Armrest colour:

- black - used with base: black, polished aluminum
- lightgrey - used with base: lightgrey.

It is no possible to purchase the chair in version without armrests.

Armrests:

P65TPU - height adjustable (range 100 mm), soft termo polyurethane (TPU) pad

P66TPU - height adjustable (range 100 mm), sliding pad adjustment (range 50 mm), with span option (range 27 mm), swivel pad adjustment (range 33°), soft termo polyurethane (TPU) pad.

Type of backrest mesh: String, Runner, Rhythm

SmartADLS - available in the 150SFL MAX, 151SFL MAX models.

Lumbar support element for 150SFL MAX and 151SFL MAX when backrest in Runner and Rhythm always the same upholstery as the seat, when backrest in String mesh - black Valencia

Irrespective of the type of the backrest, headrest is always the same upholstery as the seat.





* Only on models 150SFL MAX and 151SFL MAX.



Profim TRILLO PRO

ITO Design

- Easily adjustable basic functions.
- Synchro self mechanism ensures adjustment to user's weight,
- Several versions to choose from: backrest in plastic or with upholstered pad, plastics in two colours,
- Blue Angel certificate - confirms that our chair is environmentally friendly

Item no	Base model +	Price Group (PG)	0	①	②	③	④	⑤	Price
MSX200ST00	Profim TRILLO PRO 20ST <ul style="list-style-type: none"> • plastic backrest • self mechanism • 5-star base • base: black 		2 852	3 085	3 196	3 323	3 592	3 706	
MSX210ST00	Profim TRILLO PRO 21ST <ul style="list-style-type: none"> • plastic backrest with upholstered pad • self mechanism • 5-star base • base: black 		3 333	3 665	3 886	4 042	4 617	4 508	
MSX200HS00	Profim TRILLO PRO 20HST <ul style="list-style-type: none"> • plastic backrest • self mechanism • 4-star base, high • base: black / white / graphite / polished aluminum / MetallicPro 		3 875	4 137	4 272	4 435	4 697	4 958	
MSX210HS00	Profim TRILLO PRO 21HST <ul style="list-style-type: none"> • plastic backrest with upholstered pad • self mechanism • 4-star base, high • base: black / white / graphite / polished aluminum / MetallicPro 		4 386	4 771	5 033	5 233	5 855	5 830	

Accessories/Options/Surcharges:

7BASC006	Base: lightgray (Only for: MSX200ST00, MSX210ST00)	236
----------	--	-----

0 price group: Evo

1 price group: Cura, Tonal, Xtreme

2 price group: Select

3 price group: Capture, Oceanic, Step, Synergy

4 price group: Steelcut 3, Steelcut Trio 3

Castors/glides:

- glides (set)
- hard castors - for soft floors (set),
- soft castors - for hard floors (set).

Plastic colours:- black, grey (RAL 7043), light grey (RAL 7047).

Plastic elements: backrest and armrests.

In models 20HST / 21HST:

- base colour black / MetallicPro - plastic elements black, castors black,
- base colour white - plastic elements lightgrey (RAL 7047), castors lightgrey,
- base colour graphite - plastic elements black or grey (RAL 7043), castors black,
- base colour polished aluminium - plastic elements black, grey (RAL 7043) and castors black or plastic elements light grey (RAL 7047) and castors lightgrey.

Please clearly indicate on your order the chosen option.







www.blauer-engel.de/uz117

Profim VIOLLE

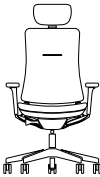
ITO Design

- Innovative synchronous mechanism equipped with essential, easily accessible adjustments which are fully integrated with the seat
- Multigrip armrests with soft pad
- Backrest with mesh or upholstery and available with lumbar support, height and depth adjustable, upholstered headrest and jacket hanger
- Function instructions also in Braille
- Plastic and aluminium parts available in several colours (white, light grey and black)
- Available in a conference version on a 4-star aluminium base
- Blue Angel certificate - confirms that chair is environmentally friendly
- Möbelfakta certificate - a guarantee of durability, safety, environmental care and social responsibility during the production process

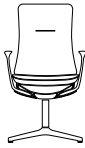
Item no	Base model +	Price Group (PG)	Price Group						Price
			0	①	②	③	④	⑤	
MLX130SF00	Profim VIOLLE 130SFL <ul style="list-style-type: none"> • swivel • high backrest • lumbar support TYPE B - height and depth adjustable • synchro mechanism • sliding seat • seat forward tilt • base: black • non-arm version • plastic colours: black • aluminum colours: white / black / polished aluminum 		8 688	9 192	9 700	10 087	11 637	10 983	12 389
MLX131SF00	Profim VIOLLE 131SFL <ul style="list-style-type: none"> • swivel • high backrest • lumbar support TYPE B - height and depth adjustable • synchro mechanism • sliding seat • seat forward tilt • base: black • non-arm version • plastic colours: black • aluminum colours: white / black / polished aluminum • headrest 		9 700	10 193	10 687	11 114	12 895	11 981	13 574
MLX150SF00	Profim VIOLLE 150SFL <ul style="list-style-type: none"> • swivel • high mesh backrest • synchro mechanism • sliding seat • seat forward tilt • base: black • non-arm version • plastic colours: black • aluminum colours: white / black / polished aluminum 		8 193	8 415	8 661	9 008	9 304	9 454	10 033
MLX151SF00	Profim VIOLLE 151SFL <ul style="list-style-type: none"> • swivel • high mesh backrest • synchro mechanism • sliding seat • seat forward tilt • base: black • non-arm version • plastic colours: black • aluminum colours: white / black / polished aluminum • headrest 		9 170	9 440	9 663	10 049	10 588	10 441	11 192

Item no	Base model +	Price Group (PG)	Price Group						Price
			0	①	②	③	④	⑤	
MLX130F000	Profim VIOLLE 130F <ul style="list-style-type: none"> • visitor • swivel • high backrest • 4-star base • base: white / black/ polished aluminum • non-arm version • teflon glides - universal 		8 478	8 959	9 464	9 843	11 402	10 737	12 167
MLX150F000	Profim VIOLLE 150F <ul style="list-style-type: none"> • visitor • swivel • high mesh backrest • 4-star base • base: white / black/ polished aluminum • non-arm version • teflon glides - universal 		7 972	8 206	8 478	8 817	9 119	9 230	9 798

Accessories/Options/Surcharges:

7BASC006	Base: lightgray (Only for: 130SFL, 131SFL, 150SFL, 151SFL)	111
7BASC002	Base: white (Only for: 130SFL, 131SFL, 150SFL, 151SFL)	752
7BASC003	Base: polished aluminum (Only for: 130SFL, 131SFL, 150SFL, 151SFL)	752
7ARMR016	Armrests P62PU - black (set) (Only for: 130SFL, 131SFL, 150SFL, 151SFL)	1839
7ARMR017	Armrests P62PU - lightgrey (set) (Only for: 130SFL, 131SFL, 150SFL, 151SFL)	2037
7ARMR001	Armrests - fixed, aluminum, polyurethane pad (set) (Only for: 130F, 150F)	1900
7LUSU003	Lumbar support TYPE B - height and depth adjustable (Only for: 150SFL, 151SFL)	358
7HANG002	Clothes hanger (HA) black or light grey - maximum load 4 kg (Only for: 130SFL, 131SFL, 150SFL, 151SFL)	506
7PLAP003	Plastic colours - lightgrey (Only for: 130SFL, 131SFL, 150SFL, 151SFL)	556

0 price group: Alba, Evo, Next

1 price group: Cura, Tonal, Xtreme

2 price group: Select

3 price group: Capture, Oceanic, Step, Synergy

4 price group: Steelcut 3, Steelcut Trio 3

Castors/glides:

- hard castors - for soft floors (set),
- soft castors - for hard floors (set),
- teflon glides - universal (set).

Glides in models 130F / 150F:

- standard - teflon glides (universal),
- option - felt glides (for hard floors).

When ordering please clearly indicate the chosen option.

Armrest P62PU black - height adjustable armrest (range 90 mm), sliding pad (range +/- 50 mm) with span option (+/- 28 mm), polyurethane pad.

Armrest PU - fixed, aluminum, polyurethane pad.

Seat covers can be made also for Rhythm and Runner upholstery. When ordering please clearly indicate the chosen option.

Gas lift with shock absorber - colour of column cover always the same as base colour.

Models Violle 130,150, 151 can be upholstered in Runner or Rhythm mesh.

Headrest may be covered in seat-upholstery or in Rhythm or Runner-mesh. Please clearly indicate on your order the chosen option.

Plastic elements: seat cover+adjustments levers, outer frame in mesh backrest, lumbar support, rear part of headrest.

Aluminium elements: armrest frame, backrest frame. It is not possible to mix different colours in particular group of elements.

In models Violle 130F / 150F gas lift with memory as standard (without height adjustment). Colour of column cover - always the same as base colour.

In models Violle 130F:

- base white and polished aluminium - cover colour lightgrey,

In models Violle 150F:

- cover colour always the same as frame of backrest.

In models with armrests:

- base white and polished aluminium, armpad lightgrey - cover colour lightgrey.

When ordering please clearly indicate the chosen option.



Technical details

Type of packaging

Box sizes legend: A - 735x760x1115 C - 670x730x835 E - 670x730x1160 G - 815x720x515 I - 815x720x1315
 B - 735x760x1315 D - 670x730x955 F - 735x720x480 H - 815x720x1115 J - 390x390x580

Product netto weight (Kg)	Assembled in foil	Assembled in Box			Semi knocked down			Fully knocked down			
	Possibility	Box size (mm)	Box weight (Kg)	Volume (m³)	Box size (mm)	Box weight (Kg)	Volume (m³)	Box size (mm)	Box weight (Kg)	Volume (m³)	
Accis^{Pro}											
150SFL	18	●	-	-	-	D	4.6	0.47	-	-	-
151SFL	18.5	●	-	-	-	D	4.6	0.47	-	-	-
Action											
100SFL / 105SFL	20.5	●	-	-	-	D	4.6	0.47	-	-	-
110SFL / 115SFL	21.5	●	-	-	-	E	4.6	0.47	-	-	-
LightUp											
230S / 230SL / 230SFL	17	●	A	4.2	0.62	C	4.5	0.41	F	4.1	0.25
250S / 250SL / 250SFL	16	●	A	4.2	0.62	C	4.5	0.41	F	4.1	0.25
230S / 230SL / 230SFL	17	●	A	4.2	0.62	C	4.5	0.41	-	-	-
250S / 250SL / 250SFL	16	●	A	4.2	0.62	C	4.5	0.41	-	-	-
330S	18.5	-	-	-	-	C	4.5	0.41	-	-	-
350S	17.5	-	-	-	-	C	4.5	0.41	-	-	-
Mickey											
Mickey	11.5	-	J	2.0	0.09	-	-	-	-	-	-
Motto											
10S/10SL/10SFL	18.5	●	A	4.2	0.62	C	4.5	0.41	F	4.1	0.25
11S/11SL / 11SFL	19.5	●	A	4.2	0.62	D	4.6	0.47	-	-	-
MyTurn											
10S	22.5	●	I	7,05	0.77	-	-	-	-	-	-
20S	21.5	●	H	6,5	0.65	-	-	-	-	-	-
Trillo^{Pro}											
20ST	11.5	-	-	-	-	-	-	-	F	4.1	0.25
21ST	12	-	-	-	-	-	-	-	F	4.1	0.25
20HST	12.5	-	-	-	-	-	-	-	G	4,65	0.30
21HST	13	-	-	-	-	-	-	-	G	4,65	0.30
Veris Net											
100SFL / 101SFL	16.5	●	A	4.2	0.62	D	4.6	0.47	-	-	-
110SFL / 111SFL	17.5	●	B	4.6	0.73	E	5	0.57	-	-	-

Type of packaging

Box sizes legend: A - 735x760x1115 C - 670x730x835 E - 670x730x1160 G - 815x720x515 I - 815x720x1315
 B - 735x760x1315 D - 670x730x955 F - 735x720x480 H - 815x720x1115

Product netto weight (Kg)	Assembled in foil	Assembled in Box			Semi knocked down			Fully knocked down			
	Possibility	Box size (mm)	Box weight (Kg)	Volume (m ³)	Box size (mm)	Box weight (Kg)	Volume (m ³)	Box size (mm)	Box weight (Kg)	Volume (m ³)	
Violle											
130	20	●	A	4.2	0.62	C	4.5	0.41	-	-	-
131	20.5	●	B	4.6	0.73	D	4.6	0.47	-	-	-
150	19.5	●	A	4.2	0.62	C	4.5	0.41	-	-	-
151	20	●	B	4.6	0.73	D	4.6	0.47	-	-	-
Xenon											
10S	19.5	●	A	4.2	0.62	C	4.5	0.41	G	4,65	0.30
10SL / 10SFL	19.5	●	A	4.2	0.62	C	4.5	0.41	G	4,65	0.30
10S	19.5	●	A	4.2	0.62	C	4.5	0.41	-	-	-
10SL / 10SFL	19.5	●	A	4.2	0.62	C	4.5	0.41	-	-	-
11S	20.5	●	B	4.6	0.73	D	4.6	0.47	-	-	-
11SL / 11SFL	20.5	●	B	4.6	0.73	D	4.6	0.47	-	-	-
Xenon Net											
100S/101S	18.5	●	A	4.2	0.62	C	4.5	0.41	G	4,65	0.30
100SL / 101SL / 100SFL / 101SFL	18.5	●	A	4.2	0.62	C	4.5	0.41	G	4,65	0.30
100S/101S	18.5	●	A	4.2	0.62	C	4.5	0.41	-	-	-
100SL / 101SL / 100SFL / 101SFL	18.5	●	A	4.2	0.62	C	4.5	0.41	-	-	-
110S / 111S	19.5	●	B	4.6	0.73	D	4.6	0.47	-	-	-
110SL / 110SFL / 111SL / 111SFL	19.5	●	B	4.6	0.73	D	4.6	0.47	-	-	-

Technical details

Accis^{Pro}

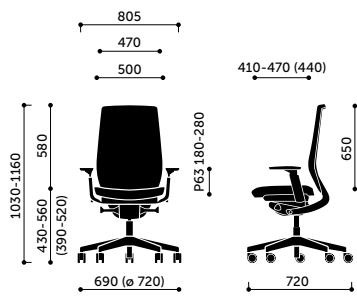

150SFL

 **18,0**

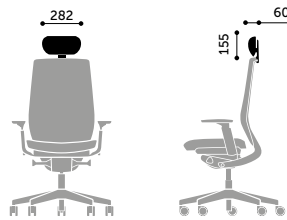

headrest

 **0,33**

Technical details

LightUp

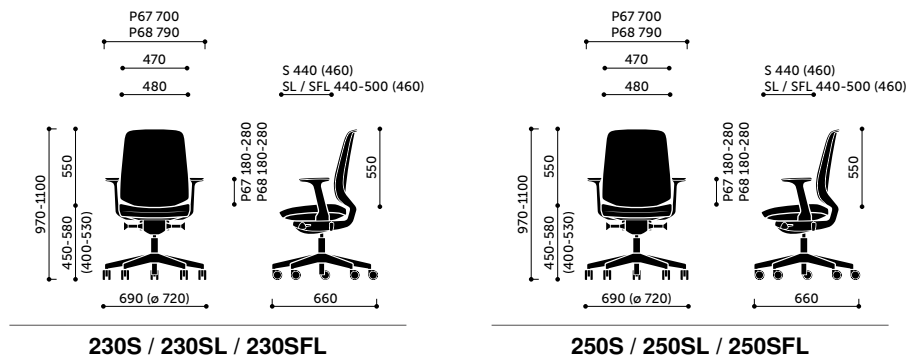

Motto

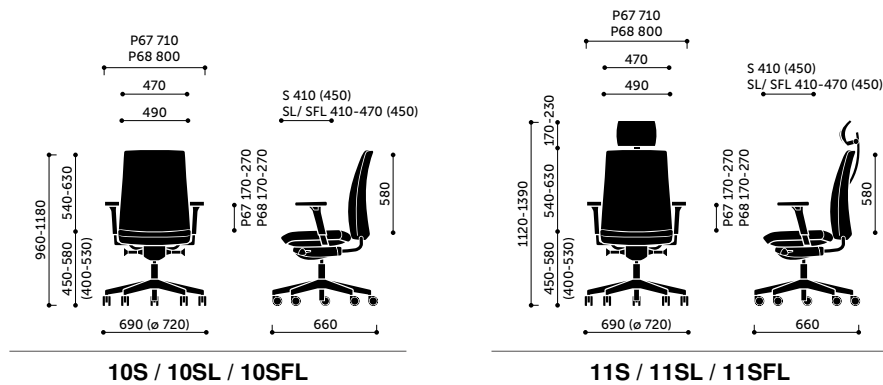

Pace

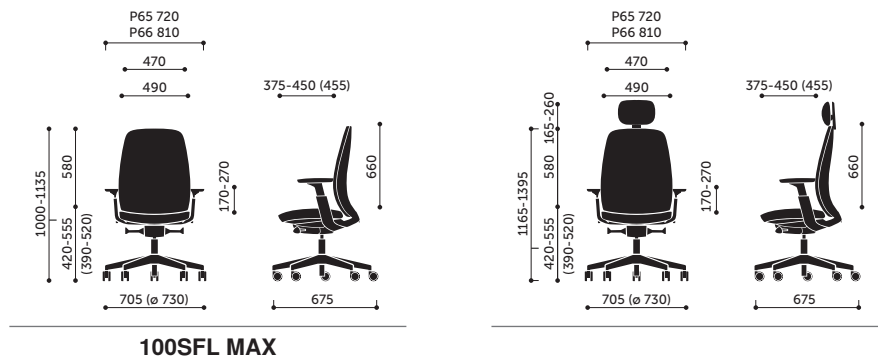

Technical details

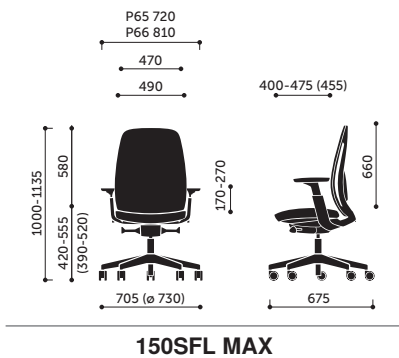

kg 18,5

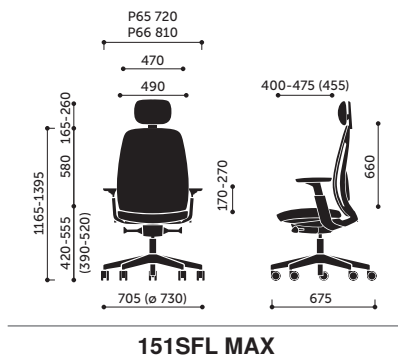

kg 19,0



Violle

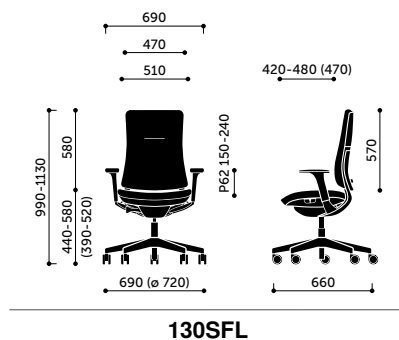

kg 23,0

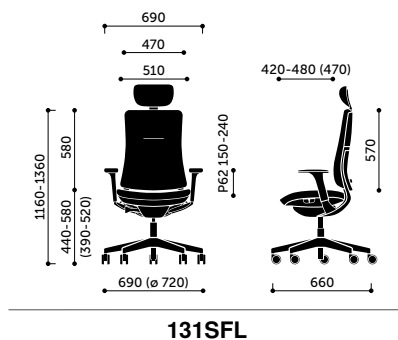

kg 25,0

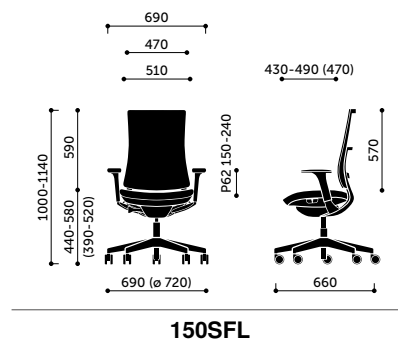

kg 22,5

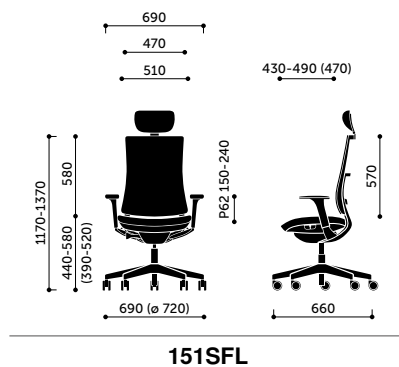

kg 24,5

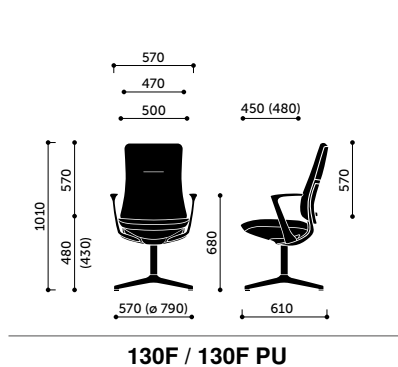

kg 17,0

2P **kg** 20,6

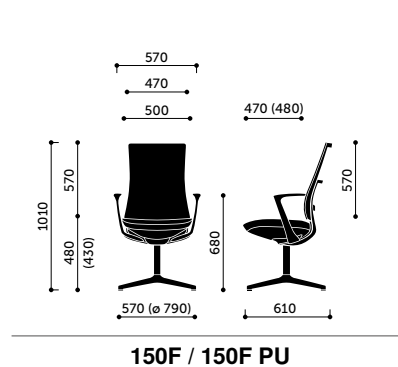

kg 16,5

2P **kg** 20,0



Mechanisms

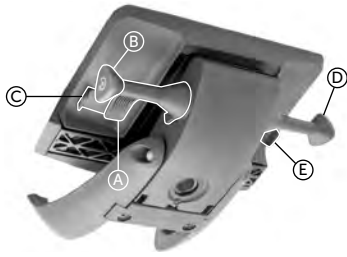

Synchro*

Accis^{Pro}

- A - Seat height
- B - Value of the backrest reclining force
- C - Seat side-movement function
- D - Tilt angle of the backrest and the seat / additional backrest and seat angle
- E - Seat depth



Synchro*

Action

- A - Seat height
- B - Tilt angle of the backrest and the seat
- C - Value of the backrest reclining force
- D - Seat depth
- E - Additional backrest and seat angle



Synchro*

Veris

- A - Seat height
- B - Tilt angle of the backrest and the seat / additional backrest and seat angle
- C - Value of the backrest reclining force
- D - Seat depth
- E - Inclination of the front part of the seat



Synchro*

Viole

- A - Seat height
- B - Tilt angle of the backrest and the seat
- C - Value of the backrest reclining force
- D - Seat depth
- E - Additional seat angle



Synchro*

LightUp / Motto / Xenon / Xenon Net

- A - Seat height
- B - Tilt angle of the backrest and the seat
- C - Value of the backrest reclining force
- D - Seat depth (only in SL and SFL models)
- E - Additional backrest and seat angle (only in SFL models)



Synchro*

MyTurn 10S, 20S

- A - Seat height
- B - Tilt angle of the backrest and the seat
- C - Value of the backrest reclining force

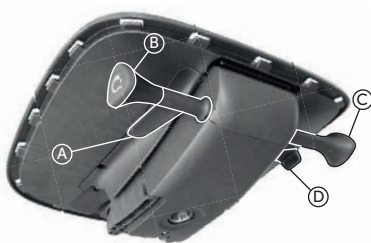

Synchro*

Pace

- A - Seat height
- B - Value of the backrest and seat reclining force
- C - Tilt angle of the backrest and the seat / additional backrest and seat angle
- D - Seat depth

Armrests

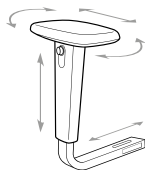

P48

Action / Veris Net

Height adjustable armrest (range 100 mm)
with span adjustment (range 35 mm on each side
- only in Veris and Veris Net),
sliding pad (range +/- 30 mm)
with pivot option (+/- 30°).
Colour of armrest frame: black.
Armpad type: PU (polyurethane pad)

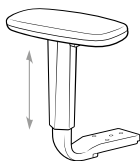

P54

Veris Net

Height adjustable armrest (range 80 mm).
Colour of armrest frame: black.
Armpad type: PU (polyurethane pad)

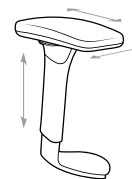

P62

Violle

Height adjustable armrest (range 90 mm),
sliding pad (range +/- 50 mm)
with span option (+/- 28 mm).
Colour of armrest frame: black, light grey,
white, graphite, polished aluminum.
Armpad type: PU (polyurethane pad)

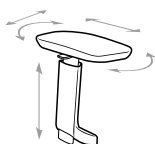

P63

Accis^{Pro}

Height adjustable armrest (range 100 mm),
sliding pad (range +/- 50 mm),
span option (+/- 27 mm),
with pivot option (+/- 33°).
Colour of armrest frame: black, light grey.
Armpad type: TPU.



P67

LightUp / Motto

Height adjustable armrest (range 100 mm).
Colour of armrest frame: black, light grey (only
LightUp).
Armpad type: TPU.



P68

LightUp / Motto

Height adjustable armrest (range 100 mm),
sliding pad (range +/- 50 mm),
span option (+/- 27 mm),
with pivot option (+/- 33°).
Colour of armrest frame: black.
Armpad type: TPU.



P65

Pace

Height adjustable armrest (range 100 mm).
Colour of armrest frame: black, light grey.
Armpad type: TPU.

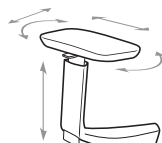

P66

Pace

Height adjustable armrest (range 100 mm),
sliding pad (range +/- 50 mm),
span option (+/- 27 mm),
with pivot option (+/- 33°).
Colour of armrest frame: black, light grey.
Armpad type: TPU.

Consumption of fabric and leather

The quantities below are only estimated. The real quantity of fabric- or leather-consumption may vary in accordance to the quantity of pieces on order. Please notice that before we accept any order in customer's own material we need to make sample trials. Please be aware that not every type of fabric/leather is suitable for upholstery. Volume of customer's own material must be agreed each time with Profim sales organization

Column A - Estimated consumption of fabric (roll width: 1,40 m)

Column B - Estimated consumption of leather (m²)

	A	B
Accis^{Pro}		
150	0,7	0,8

Action		
100, 110	1,5	2,0
105, 115	0,6	0,8
580	1,2	-

LightUp		
230, 330	1,2	-
250, 350	0,5	-

Motto		
10	1,4	-
11	1,8	-

MyTurn		
10	1,7	2,3
20	1,6	2,1

Veris		
10, 101	1,5	1,2
11, 111	1,8	1,2

Violle		
130SFL	1,8	1,5
131SFL	2,1	1,7
150SFL	0,6	0,6
151SFL	0,9	0,8
130F	1,8	1,5
150F	0,6	0,6

Xenon		
10	1,5	1,5
11	1,9	1,7

Xenon Net		
100, 101	0,7	0,7
110, 111	1,1	0,9

Measuring methodology

Swivel armchairs and chairs are measured with a mechanism adjusted in such a way that the seat is as much as it is possible positioned levelly, while the backrest vertically. Swivel armchairs and chairs are measured on their castors, whereas visitor and reception chairs on hard glides. The measurements are approximate and can differ depending on the product configuration.

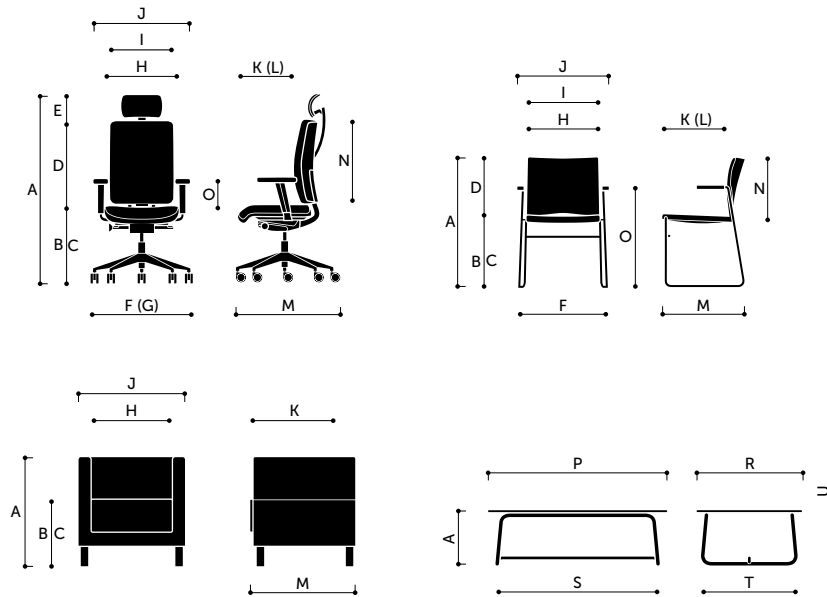

A - Total height

For products fitted with a gas lift - it is measured with gas lift's minimum and maximum extension. For products fitted with an additional backrest and headrest height adjustment - it is measured in both minimum and maximum positions of the backrest, headrest and gas lift.

B - Seat height

Measured at the highest point of the seat. For products fitted with a gas lift - it is measured with absorber's minimum and maximum extension.

C - Seat height with the burden

Seat measured according to EN standards (with seat burden). For products fitted with a gas lift - it is measured with gas lift's minimum and maximum extension.

D - Backrest height

Measured from the seat to the backrest upper edge. For products with adjustable backrest height - it is measured in the minimum and maximum position.

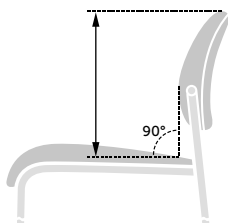

E - Headrest height

Measured from the backrest upper edge to the headrest upper edge. The headrest adjusted in maximum vertical position in relation to the upper and lower edge of the headrest. Measured in the headrest's minimum and maximum position.

F - Base, frame width

Measured at the uttermost points of the base according to the following figures.

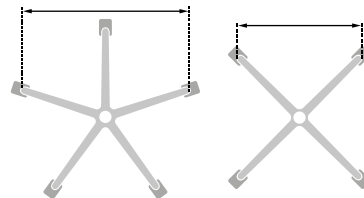

G - Base diameter

Measured according to the figure underneath.

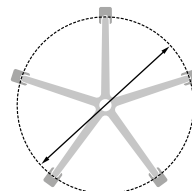

H - Seat width

Measured at the uttermost points of the seat.

I - Backrest width

Measured at the uttermost points of the backrest.

J - Total width

Measured at the uttermost points. For products fitted with adjustable armrests - it is measured with the armrests slid apart to maximum. For products fitted with armrests with adjustable pads - it is measured with the pads slid apart to maximum.

Measuring methodology

K - Seat depth

Measuring the distance between the uttermost point on the seat and the point it touches the backrest (the contact point is determined with a level positioned vertically to the backrest by projecting the S point from the backrest onto the seat) (1). For some shell chairs, where there is no distinct border-line between the seat and the backrest, the depth is measured on the bend halfway between the seat and the backrest (2). For products with additional adjustable seat depth - it is measured with minimum and maximum slide.

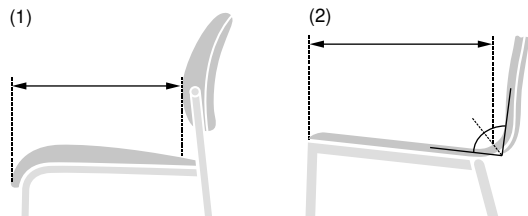

L - Seat (element) length

Measured at the uttermost points of the seat.

M - Total depth

Measured at the uttermost points. Swivel armchairs and chairs are measured according to the drawing underneath. For products with adjustable seat depth - it is measured with minimum and maximum slide.

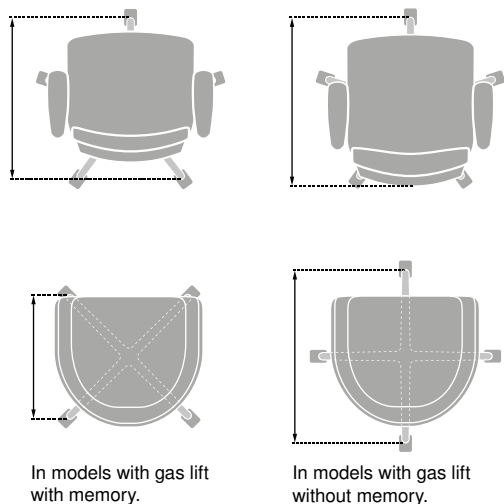

N - Backrest (element) length

Measured at the uttermost points of the backrest.

O - Armrest height

For swivel armchairs and chairs – it is measured from the seat surface to the armrest upper edge. For armrests with adjustable height – it is measured in the minimum and maximum position. For visitor chairs – it is measured from the floor to the armrest upper edge.

P - Table top length

Measured at the uttermost points of the table top.

R - Table top width

Measured at the uttermost points of the table top.

S - Table frame length

Measured at the uttermost points of the table frame.

T - Table frame width

Measured at the uttermost points of the table frame.

U - Table top thickness

Table top (element) thickness is measured.

Terms of guarantee

applies to products manufactured after January 15th, 2019

1. Profim (the Guarantor) guarantees the efficient operation of its products.
2. Claims must be submitted at the purchase location, on a claims form (which can be downloaded from www.profim.eu), together with a purchase document (invoice or guarantee) and the guarantee certificate, if the certificate in question was issued to the Purchaser.
3. Claimed products will be accepted only if cleaned, packaged, and secured against damage in shipping.
4. The claimed product should be delivered, along with the documents listed in point 2, to the purchase location. If the claim is rejected, the product is sent back to the purchase location at the cost of the Purchaser.
5. The Guarantor shall determine whether the claim is justified within 14 days from the claimed products' delivery to manufacturer (together with claim application). A claims department employee will contact the Purchaser by phone or e-mail in order to determine the date and manner of product repair/replacement. Any doubts related to the claims procedure may be clarified at the phone number + 48 63 289 88 40 from Monday to Friday, 9-15, or at the e-mail address export@profim.pl. Submitting a claim does not entitle the Purchaser to withhold payment for the product.
6. In order to enable the manufacturer to identify the product, the claim notice should include information from the product's LABEL, i.e. the date of manufacture, order number, product number, and configuration. Any tampering with the LABEL will cause the guarantee to become null and void.
7. Guarantee period.
Refers to the products listed in the current price list and on the website www.profim.eu.

Guarantee period	Offer	Operating mode
5 years not longer however than 7 years from production date	Standard Classic - selected products	5 days a week, 8 hours per day (single shift work)
3 years not longer however than 4 years from production date	Classic	5 days a week, 8 hours per day (single shift work)

8. If the product is used for more than 8 hours per day, the guarantee period is reduced to three years.
9. Chair parts (e.g. castors, mechanisms, plastic parts) sold to the Purchaser are covered by a 2 years warranty.
10. If the product is replaced with another product free of defects or repaired by having one of its parts replaced, the course of the guarantee for such product or element is restarted. The guarantee period is extended by the period in which the Purchaser could not make use of the product.
11. If a defect cannot be removed or the removal involves excessive costs, the Guarantor may replace the product with another product free of defects. Any replaced defective products or parts thereof become the property of the Guarantor.
12. In case where an identical product is not available, the Guarantor may replace it with another product free of defects and with identical/similar parameters.

13. Claims concerning mechanical damage (scratches, dents, abrasions, upholstery soiling, missing parts etc.) will be accepted only if submitted within 7 days from the date of handing the product over to the Purchaser. By the above deadline, the Purchaser should unpack the product and remove the wrapping and protective elements in order to rule out mechanical damage. If reservations are made upon delivery with respect to the delivered product, a damage protocol must be drawn up in the presence of the courier or carrier and sent to the Guarantor together with the claims notice.
14. The refusal to hand the product (or any part thereof) over for repair in factory conditions, or preventing repair at the site of the Purchaser, causes the Guarantor to be released from its guarantee obligations and any guarantee claims to be waived.
15. The date of product repair at the site of the Purchaser is scheduled by the Guarantor.
16. Customized products i.e. chairs covered with fabric provided by the Purchaser and manufactured using technology that is not standard for a given product (such as using another base, armrests, covered by a fabric that is not part of standard offer etc.) are covered by one year guarantee.
17. The guarantee covers solely products located on the territory of the Republic of Poland or the country of the Distributor.
18. The Guarantor reserves the right to make innovations in the products that do not alter their durability and usability.
19. Repairs conducted by unauthorized persons or using unauthorized parts will cause the guarantee to become null and void.
20. The Purchaser's rights hereunder do not include the right to pursue lost profits and be indemnified for any potential damage caused by product failure.
21. The Guarantor's liability covers solely defects inherent in the product sold.
22. If the product is damaged after the expiry of the guarantee, the Guarantor may send, if possible, the Purchaser the required element or cure the defect using its factory service. In both cases the Purchaser will be charged accordingly.

Terms of guarantee

applies to products manufactured after January 15th, 2019

THE GUARANTEE DOES NOT COVER:

- a) defects caused by assembling the product in a manner not compliant with the manual and using it in a manner not compliant with its purpose,
- b) damage caused during transport and transloading (does not apply to transport provided by the Guarantor),
- c) failure to observe the recommendations contained in the user's manual, damage to castors, glides or floor caused by the inappropriate choice of available options (e.g. using hard castors on hard surfaces); the proper choice of options does not rule out damages that may be caused by using the chairs on carpets, panels, parquet floors etc. of inappropriate quality or on soiled surfaces (e.g. by sand),
- d) damage resulting from extreme climate conditions or environmental factors (e.g. acids, humidity etc.),
- e) damage caused by departing from standard specifications at the customer's request,
- f) operational wear and tear of wheels or upholstery materials,
- g) wear and tear of felt glides, which can be replaced under warranty, only in case the felt come away,
- h) differences in the fabrics shade, if the products come from different manufacturing series of the fabric manufacturer, and differences in individual products purchased by the Purchaser successively are claimed,
- i) discoloration of upholstery caused by some of the clothing colourants and additional colourants (such as those used in denim) which may transfer onto lighter upholstery (the effect can be intensified due to humidity and temperature and is irreversible),
- j) soiling and permanent discolouring of upholstery caused by external factors,
- k) leather upholstery products, where the natural features of the material, such as smell, difference in the structure, texture and shade differences, scars and insects pricks are claimed; during use (e.g. on the seat) the leather takes on shine and becomes looser; the Guarantor does not accept claims motivated by the above features,
- l) foam deformations,
- m) differences in the hardness of polyurethane cold-moulded foam resulting from parameter variations, which according to the DIN 53576/ISO 2439 norm are acceptable if within the range of +/- 10%,
- n) damaging the surface of wooden elements as a result of contact with the edges of desks or other office furniture; mechanical damage of wooden surfaces is not considered to be a product defect,
- o) wooden components used in products, if the slight differences occurring in individual elements are claimed; the character of the raw material makes it impossible to precisely determine the final aesthetic effects, defined by the wood colour, shade, and figure,
- p) differences in geometry of plywood shells, which, because of their natural properties, may differ in tolerance of +/- 1.5 degrees,
- r) small variations in HPL colours, in accordance with PN-EN 438 norm.
- s) differences in colour, gloss, tone or pattern in ceramic table tops. It is natural material and above features are characteristic of this type of surface.

GENERAL REMARKS CONCERNING PRODUCT USE:

23. The products should be protected against the direct influence of sunrays.
24. Leather products should not be placed next to a heater or another heat source. Please observe a minimum distance of 30 cm from the heat source.
25. Leather should be maintained using special care products that create a protective layer resistant to water and oil substances.
26. Products should be protected against becoming wet.
27. The upholstery fabric should be protected against soiling by grease, sweat, lubricants etc. In case of soiling, apply appropriate cleaning agents.
28. Avoid exposing upholstery to extensive, focused tension (for example standing on a chair) that can result in splitting or a rip of stitching as well as mechanical damage to upholstery.
29. Upholstered furniture is supposed to be used to sit evenly on the seat surface to avoid natural tendency of fabrics and leather to creasing and wrinkling due to ongoing pressure, temperature and the moist of the body (wrinkling and creasing is not a product fault but a natural effect; the bigger the upholstered surface the higher tendency for this effect to occur).
30. Products should be dusted at least once a week.
31. Hard castors are used with soft carpeting and carpets.
32. Soft castors are used with hard floors (e.g. PVC, parquet floors, floor panels).
33. Remarks concerning the use of products containing plywood elements:
 - temperature range from +15°C to +30°C,
 - humidity range from 40% to 65%.
34. Ceramic tops meet the frost resistance requirements per EN 10545-12.
35. Table Chic RH and RR with metal and ceramic table top (apply only when frame/column is made of EPO1, EPO2, EPO3, with hard or teflon glides) can be for outdoor use according to EN 12944-2 cat. C3.
36. Plastic elements of the products like bases, armrests cover (especially light grey colours) require regular cleaning adequate to density of usage.

Fabrics and finishings

Profim Standard fabrics

ALBA (FIDIVI)

Alba is a uni-coloured polyester fabric with a grainy texture. The weave construction play with light and add depth to the colours.

Composition: 100% polyester

Weight: 320 +/- 5% g/m²

Abrasion resistance: 100 000 Martindale (EN ISO 12947-2)

Flammability: BS EN 1021: 1-2 (Cigarette & match), CA TB 117-2013, BS 5852 Crib 5, BS 7176 Medium Hazard, UNI 9175 Class 1 IM

Light fastness: 6 (EN ISO 105 - B02: 2013)

Rubbing fastness: 4/5 (Wet/Dry) (ISO 105-X12)

Pilling: 5 (EN ISO 13945-2)

Environmental facts: Oeko-Tex® Standard 100, Indoor Advantage™ "Gold", non-metallic dyestuff, does not contain flame-retardant chemicals, ISO 14001 certified company.

Design: FIDIVI Design Team

Produced in: South Korea

Cleaning & disinfection: Washable up to 60°, dry cleanable with perchloroethylene, cleanable with steam, bleach and the most common sanitizing agents. (For further info follow FIDIVI's cleaning guidelines - www.fidivi.com)

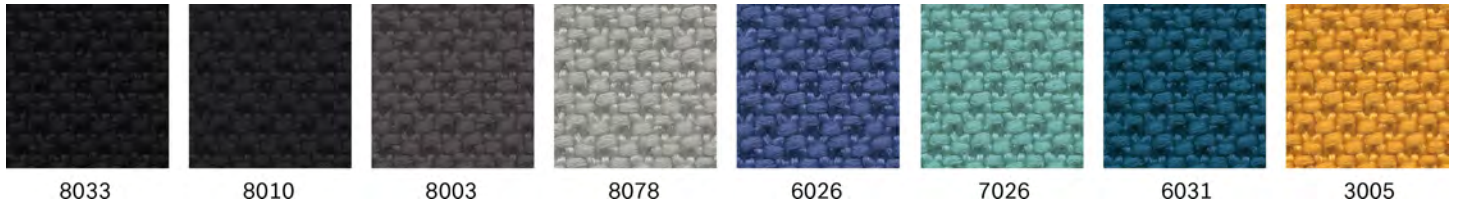

EVO - PRICE GROUP 0

Evo is a uni-coloured polyester crepe fabric. The irregular weave structure add shine and good stretch.

Composition: 100% polyester

Weight: 320 g/m²

Abrasion resistance: 180 000 Martindale (EN ISO 12947-2)

Flammability: BS EN 1021: 1-2 (Cigarette & match)

Light fastness: 4-5 (EN ISO 105-B02)

Rubbing fastness: 4-5 (Wet/Dry) (EN ISO 105-X12)

Pilling resistance: 5 (EN ISO 12945-2)

Environmental facts: EU Ecolabel, Oeko-Tex® Standard 100, ISO 14001 certified company

Design: Miranda Design Team

Produced in: Poland

Cleaning & disinfection: Dry cleaning with tetrachloroethylene and water solution of carbonate fluoride

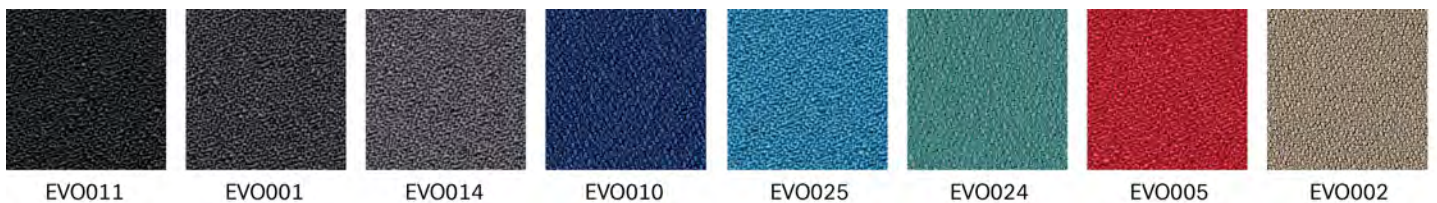

NEXT - PRICE GROUP UNDEFINED

Next is a polyester fabric in solid and mixed colors. It is lightly textured with a semi-gloss surface.

Composition: 100% polyester

Weight: 340 g/m²

Abrasion resistance: 100,000 Martindale (EN ISO 12947-2)

Flame safety: BS EN 1021: 1-2 (Cigarette & match)

Light fastness: 5 (EN ISO 105-B02)

Rubbing resistance: 4-5 (Wet/Dry) (EN ISO 105-X12)

Picking resistance: 5 (EN ISO 12945-2)

Environmental facts: Oeko-Tex® Standard 100, ISO 14001 Certified company

Cleaning and disinfection: Dry cleaning with tetrachlorethylene and aqueous solution of carbonate fluoride

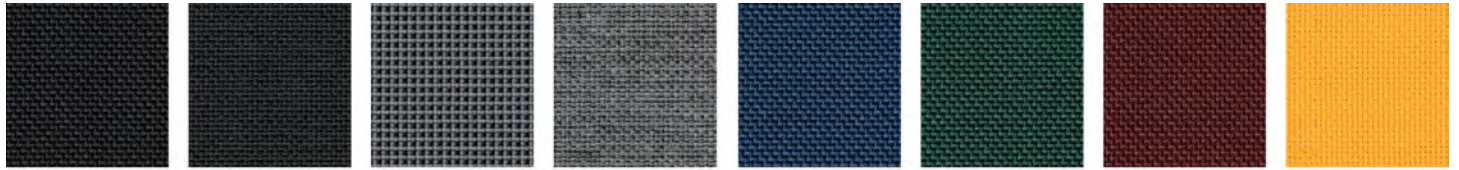

NX-16

NX-14

NX-12

NX-10

NX-15

NX-11

NX-7

NX-1

CURA (GABRIEL) - PRICE GROUP 1

Cura is a two-coloured fabric made from 100% post-consumer recycled polyester. It has a matt, slightly irregular and natural-looking texture where the dark, underlying grey fibers create a discreet yet vibrant melange effect. High durability and stretchability and its soft, voluminous touch make Cura suitable for both office and lounge furniture.

Composition: 100% post-consumer recycled polyester

Weight: 420 g/lm

Abrasion resistance: 100 000 Martindale (EN ISO 12947-2)

Flammability: BS EN 1021: 1-2, BS 5852 0&1, CA TB 117-2013, ASTM E 84 Class I

Light fastness: 5-8 (EN ISO 105 - B02)

Rubbing fastness: 4-5/4-5 (Wet/Dry) (EN ISO 105X12)

Pilling: 4-5 (EN ISO 12945-2)

Environmental facts: EU Ecolabel, Oeko-Tex® Standard 100, Contains no Flame Retardant chemicals, ISO 14001 certified company

Design: Cenk Kivrikoglu

Produced in: Lithuania

Cleaning: Wash or dry cleaning. Can be disinfected with ethanol and is bleach-cleanable (For further info follow Gabriel´s cleaning guidelines - www.gabriel.dk)

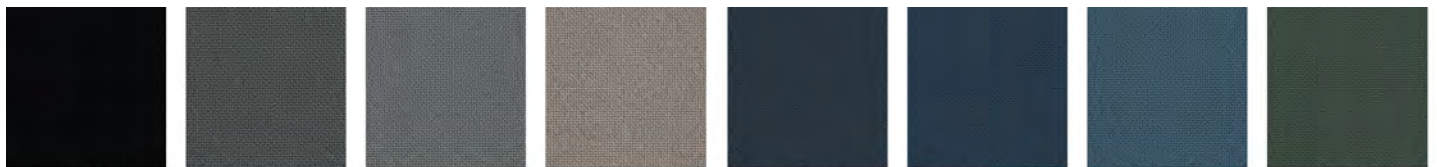

CU60999

CU60109

CU60110

CU61168

CU66165

CU66170

CU66167

CU68182



CU68186



CU62083

TONAL (GABRIEL) - PRICE GROUP 1

Tonal is a post-consumer recycled polyester fabric in a two-coloured melange. It has a discreet textured look with a fusion of light and dark tones adding depth to the colours.

Composition: 99% post-consumer recycled polyester, 1% polyester

Weight: 315 g/lm

Abrasion resistance: 100 000 Martindale (EN ISO 12947-2)

Flammability: BS EN 1021: 1-2, BS 476 Part 7 class 1, CA TB 117-2013, ASTM E 84 Class I

Light fastness: 6-8 (EN ISO 105 - B02)

Rubbing fastness: 4-5/4-5 (Wet/Dry) (EN ISO 105X12)

Pilling: 4-5 (EN ISO 12945-2)

Environmental facts: EU Ecolabel, Oeko-Tex® Standard 100, Contains no Flame Retardant chemicals, ISO 14001 certified company

Design: Cenk Kivrikoglu

Produced in: Lithuania

Cleaning: Wash or dry cleaning. Can be disinfected with ethanol and is bleach-cleanable (For further info follow Gabriel's cleaning guidelines - www.gabriel.dk)

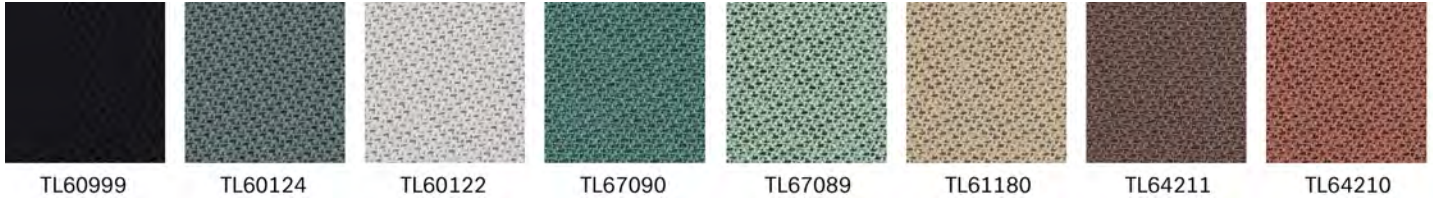

XTREME (CAMIRA) - PRICE GROUP 1

Xtreme is a crepe fabric made from 100% post-consumer recycled polyester that features exceptional Euro flammability performance. Extra stretch and structure gives an irregular, shiny finish.

Composition: 100% post-consumer recycled polyester

Weight: 310 g/m²

Abrasion resistance: >100 000 Martindale (EN ISO 12947-2)

Flammability: BS EN 1021: 1-2 (Cigarette & match), BS 7176 Low & Medium Hazard, BS 5852 Section 4 Crib 5, DIN 4102 B1, UNI 9175 Class 1 IM, NF D 60-013

Light fastness: 6 (EN ISO 105 - B02: 2013)

Rubbing fastness: 4/4 (Wet/Dry) (EN ISO 105X12)

Pilling: 5 (EN ISO 12945-2)

Environmental facts: EU Ecolabel, Oeko-Tex® Standard 100, Indoor Advantage™ "Gold", non metallic dyestuffs, ISO 14001 certified company.

Design: Camira Design Studio

Produced in: United Kingdom

Cleaning & disinfection: Washable to 60°C and bleach cleanable (For further info follow Camira's cleaning guidelines - www.camirafabrics.com)

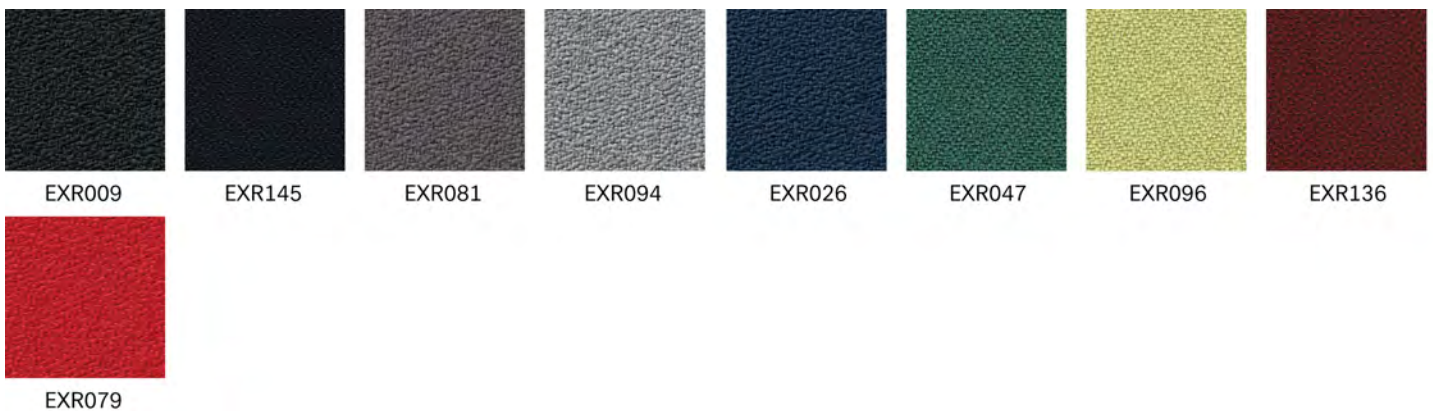

SELECT (GABRIEL) - PRICE GROUP 2

Select is a classic woolen fabric with a tightly woven relief structure, combining excellent softness, stretch and durability. Its rich texture with the interplay of light and shadow add depth in all the colours in the palette.

Composition: 85% New Zealand wool, 15% polyamide

Abrasion resistance: 200 000 Martindale (EN ISO 12947-2)

Flammability: BS EN 1021: 1-2, BS 5852 0&1, BS5852 Crib 5, CA TB 117-2013, IMO MSC 307(88) Annex 1 part 8/MED registration IMO

Light fastness: 5-8 (EN ISO 105 - B02)

Rubbing fastness: 4-5/4-5 (Wet/Dry) (EN ISO 105X12)

Pilling: 4 (EN ISO 12945-2)

Environmental facts: EU Ecolabel, Oeko-Tex® Standard 100, 100% free of heavy metals, ISO 14001 certified company

Design: Cenk Kivrikoglu

Produced in: Lithuania

Cleaning: Professional dry cleaning (For further info follow Gabriel's cleaning guidelines - www.gabriel.dk)

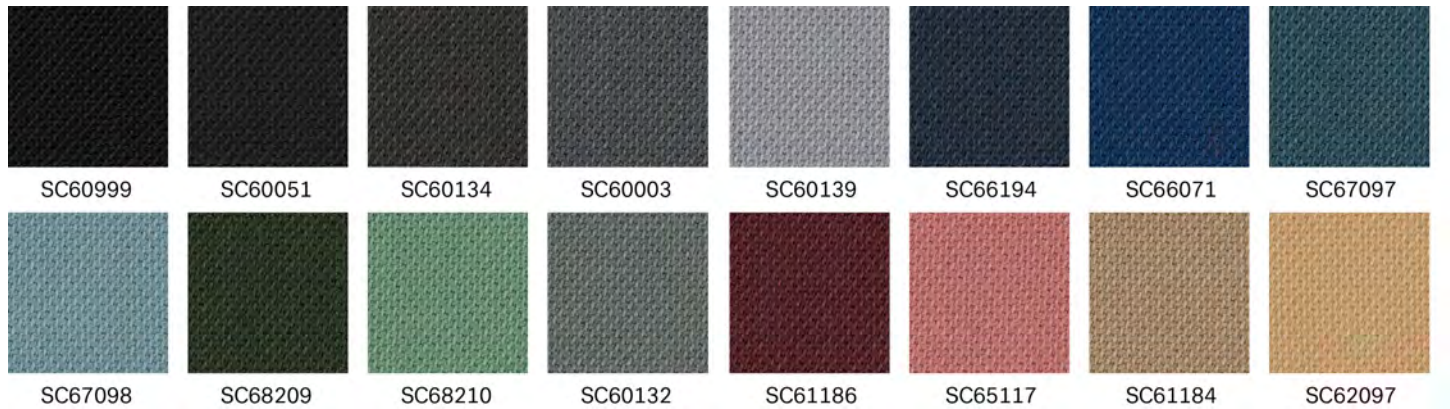

CAPTURE (GABRIEL) - PRICE GROUP 3

Capture is a lightly felted and multi-coloured wool fabric combining softness, stretch and strenght. It fuses light and dark colours to a refined melange pattern in subtle nuances, which add richness and depth to the design.

Composition: 85% New Zealand wool, 15% polyamide

Abrasion resistance: 200.000 Martindale (EN ISO 12947-2)

Flammability: BS EN 1021: 1-2 (Cigarette & match), BS 5852 Part 1 0,1 (Cigarette & match), CA TB 117-2013, Class Uno UNI 9175 Class 1 IM

Light fastness: 5-7 (EN ISO 105-B02)

Rubbing fastness: 4-5/4-5 (Wet/Dry) (EN ISO 105X12)

Pilling: 4-5 (EN-ISO 12945-2)

Environmental facts: EU Ecolabel, Oeko-Tex® Standard 100, 100% free of heavy metals, ISO 14001 certified company

Design: Cenk Kivrikoglu

Produced in: Lithuania

Cleaning: Professional dry cleaning (For further info follow Gabriel's cleaning guidelines - www.gabriel.dk)

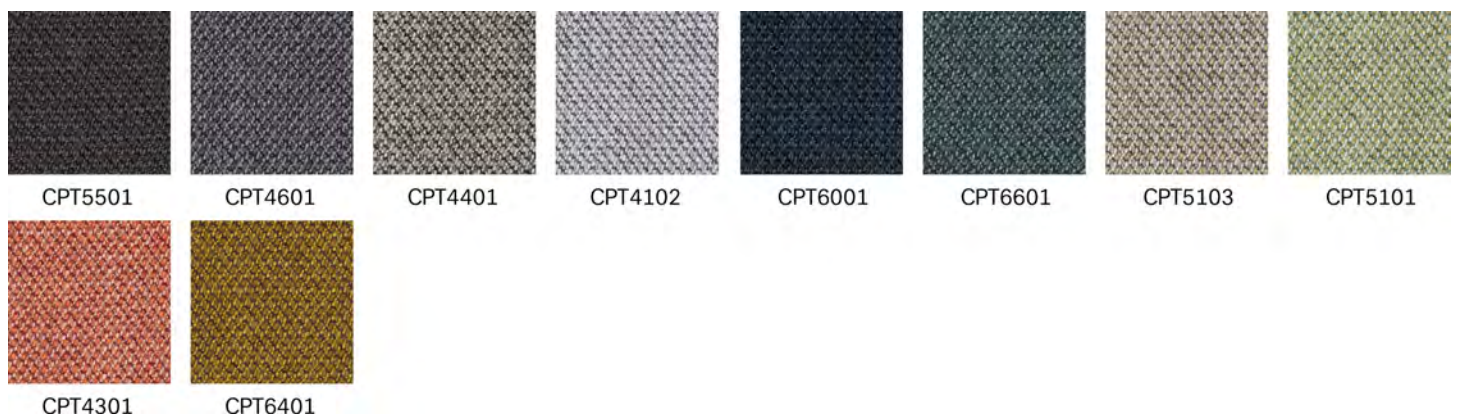

OCEANIC (CAMIRA) - PRICE GROUP 3

Oceanic is made from 100 % post-consumer recycled polyester yarn where 90% are created from post-consumer plastic bottles diverted from landfill and 10% is upcycled marine plastic(from marine litter). It is a fabric born out of the SEAQUAL Initiative designed to combat marine plastic pollution and achieve a waste free environment. Oceanic has a two coloured diagonal structure with a matte surface and soft touch.

Composition: 100 % post-consumer recycled polyester, including 50% SEAQUAL yarn

Weight: 497 g/m² ±5%

Abrasion resistance: >100 000 Martindale (EN ISO 12947-2)

Flammability: BS EN 1021: 1-2 (Cigarette & match), BS 7176 Low, BS 7176 Medium Hazard with EnviroFlam5, CA TB 117-2013

Light fastness: 5 (EN ISO 105 - B02: 2013)

Rubbing fastness: 4/4 (Wet/Dry) (EN ISO 105X12)

Pilling: 4 (EN ISO 12945-2)

Environmental facts: EU Ecolabel, Oeko-Tex® Standard 100, Indoor Advantage™ "Gold", non metallic dyestuffs, ISO 14001 certified company.

Design: Camira Design Studio

Produced in: United Kingdom

Cleaning & disinfection: Washable at 60 °C and bleach cleanable (For further info follow Camira´s cleaning guidelines – www.camirafabrics.com)



STEP (GABRIEL) - PRICE GROUP 3

Step is unique in both texture and performance. With its delicate surface, Step is perceived as vivid and interesting. The texture with the fire-resistant Trevira CS yarn ensures that the fabric is suited for use in environments with high fire safety and durability requirements.

Composition: 100% Trevira CS

Weight: 336 g/m²

Composition: 100% Trevira cs

Abrasion resistance: 100 000 Martindale (EN ISO 12947-2)

Flammability: BS EN 1021: 1&2 (Cigarette & match), BS 5852 0&1 (Cigarette & match), BS 5852 Crib 5, CA TB 117-2013, MED Certificate IMO, Class Uno UNI 9175 Class 1 EMME, ÖNORM

Light fastness: 5-7 (EN ISO 105 - B02)

Rubbing fastness: 4-5/4-5 (Wet/Dry) (EN ISO 105X12)

Pilling: 4-5 (EN ISO 12945-2)

Environmental facts: EU Ecolabel, Oeko-Tex® Standard 100, 100% free of heavy metals, ISO 14001 certified company

Design: Inger Mosholt Nielsen

Produced in: Lithuania

Cleaning: Professional dry cleaning (For further info follow Gabriel's cleaning guidelines www.gabriel.dk)

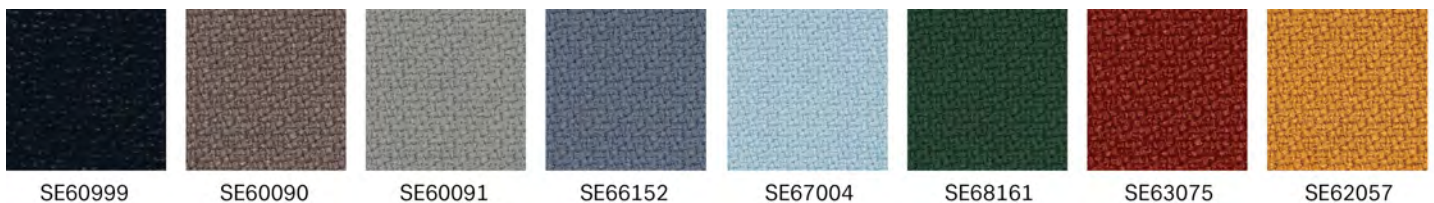

SYNERGY (CAMIRA) - PRICE GROUP 3

Epitomising natural simplicity, Synergy is a wool rich fabric which is at once both irresistibly soft and ultra-high performing. Delicately felted, with a beautifully relaxed drape, the understated aesthetics showcase the intriguing coloration of this considered textile.

- **Composition:**
 - 95% wool
 - 5% polyamide
- **Weight:** 400 g/m²
- **Certificates:**
 - **Abrasion resistance:** 100000 Martindale cycles (BS-EN ISO 12947-2)
 - **Pilling resistance:** 4 (BS-EN ISO 12945-2)
 - **Flammability:** cigarette (BS-EN 1021-1)
 - **Flammability:** match (BS-EN 1021-2)
 - **Flammability:** (UNI 9175 Class 1IM)
 - **Light fastness:** 5 (ISO 105-B02)
- **Maintenance:**
 - -vacuum regularly
 - -use dry-clean preparations
 - -do not bleach

Because of the fact that the fabric Synergy is composed of 95% natural fiber, each of the batches shows variations in shade, which may be visible in products of follow-up orders. Additionally, an inherent feature of all natural fibers is the tendency to delicate fabric pilling.

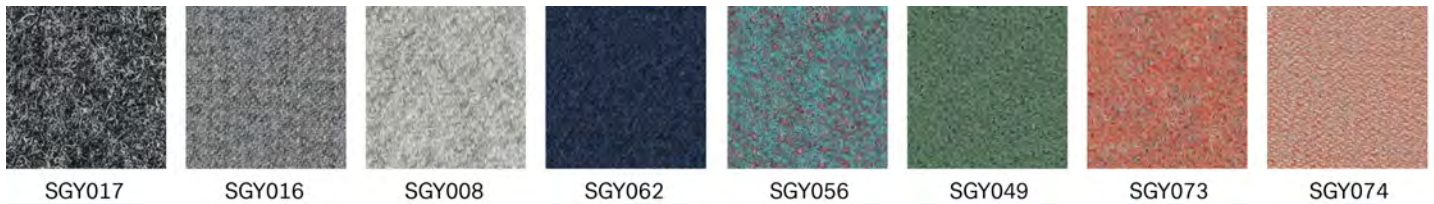

STEELCUT 3 (KVADRAT) - PRICE GROUP 4

Steelcut 3 is a unicoloured strong worsted wool and polyamide woven fabric, combining durability, soft touch and colour depth. The construction create a three-dimensional surface resembling small pyramids or steel points. Despite its complex weaving technique, it has a simple and precise expression.

Composition: 90% worsted new wool, 10% polyamide

Weight: 825 g/lm

Abrasion resistance: 100 000 Martindale (EN ISO 12947-2)

Flammability: BS EN 1021: 1-2 (Cigarette & match, CA TB 117-2013, BS 5852 Crib 5 (with treatment), BS 5852 part 1, IMO FTP Code 2010 Part 8, NF D 60 013, NFPA 260, UNI 9175 1IM, ÖNORM B1/Q1, AS/NZS 3837 Class 2, ASTM E84 Class A Unadhered, ASTM 84 Class B Adhered

Light fastness: 5 6 (EN ISO 105-B02)

Rubbing fastness: 3-5/4-5 (Wet/Dry) (EN ISO 105X12)

Pilling: 3-4 (EN ISO 12945-2)

Environmental facts: EU Ecolabel, 100% free of heavy metals, ISO 14001 certified company, GREENGUARD Gold

Design: Frans Dijkmeijer, Giulio Ridolfo (updated colourways)

Produced in: United Kingdom

Cleaning: Professional dry cleaning with tetrachloroethylene, normal process (For further info follow Kvadrat´s cleaning guidelines – www.kvadrat.dk)

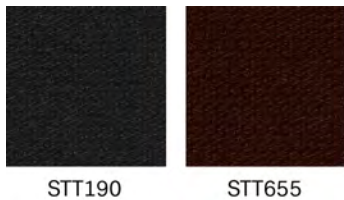

STEELCUT TRIO 3 (KVADRAT) - PRICE GROUP 4

Steelcut Trio 3 is a strong worsted wool and polyamide woven fabric, made with three different coloured yarns. The colours and the special weave create a three-dimensional surface where the colours seem to change depending on the angle of perspective. Like Steelcut 3, despite the complexity of the textile's innovative weave, it has a simple, precise expression.

Composition: 90% worsted new wool, 10% polyamide

Weight: 770 g/lm

Abrasion resistance: 100 000 Martindale (EN ISO 12947-2)

Flammability: BS EN 1021: 1-2 (Cigarette & match, CA TB 117-2013, , BS 5852 Crib 5 (with treatment), BS 5852 part 1, BS 5852 ignition source 3, IMO FTP Code 2010 Part 8, NF D 60 013, NFPA 260, UNI 9175 1IM, ÖNORM B1/Q1, AS/NZS 3837 Class 2, GB 50222 B1 with treatment (Chinese)

Light fastness: 6-7 (EN ISO 105-B02)

Rubbing fastness: 3-5/4-5 (Wet/Dry) (EN ISO 105X12)

Pilling: 4 (EN ISO 12945-2)

Environmental facts: EU Ecolabel, 100% free of heavy metals, ISO 14001 certified company, GREENGUARD Gold

Design: Frans Dijkmeijer, Giulio Ridolfo (updated colourways)

Produced in: United Kingdom

Cleaning: Professional dry cleaning with tetrachloroethylene, normal process (For further info follow Kvadrat's cleaning guidelines - www.kvadrat.dk)

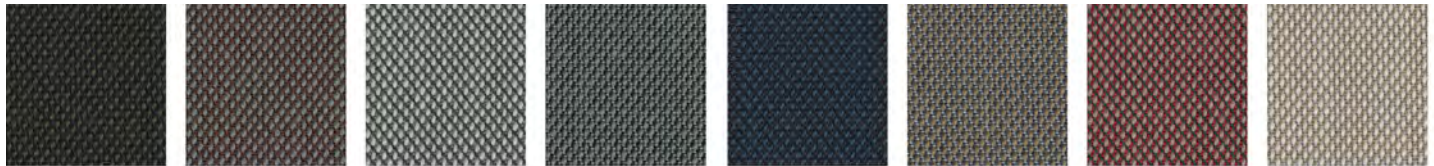

STT383

STT276

STT133

STT153

STT796

STT253

STT645

STT213

PALOMA SOFT (WOLLSDORF) - PRICE GROUP 6

High quality semi-aniline leather. All our standard colours from Paloma have a special finish adding a particular softness to the leather. Excellent friction and breathing properties. The surface may feature small scars and marks resulting from insect bites etc. These are proof of the natural origin of the product and are part of its character.

Flammability: BS EN 1021: 1-2 (Cigarette & match), BS 5852 Crib 5, IMO A.652 (16)

Light fastness: 6 (EN ISO 105-B02)

Rubbing: Wet 80/4 -Dry 2000/4 - Sweat 50/4 - ISO 11640

Finish-adhesion: 2,0 N/cm ISO 11644

Tear-strength: 20 N/mm DIN 53329- A

Environmental facts: Tanned without using chromium salts, BlueAngel, ECO2L-certificate, ISO 14001 certified company

Produced in: Austria

Animal Welfare: All hides are by-products from the meat and dairy industries, only use hides from healthy and uninjured animal. Following European standards as a minimum and the "Five Freedoms" of livestock as defined by FAWC (Farm Animal Welfare Council)

Cleaning: Follow the leather care guide from our supplier - www.wollsdorf.com



ATG56100

ATG55185

ATG55206

ATG55115

ATG55130

Fabrics and finishings

Mesh

Ariz

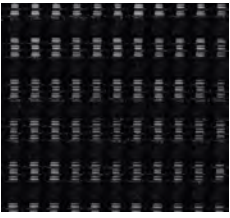

GZ-21

Mesh

Bit



Runner 60061

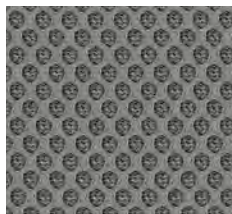

Runner 60011



Runner 60999

Plastics

Ariz

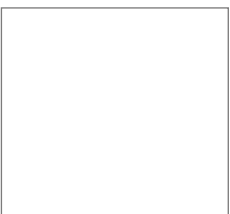

CODE 20



CODE 517

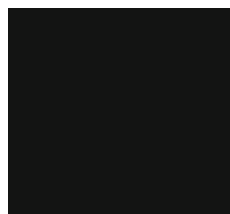

CODE 01



CODE 516



CODE 503



CODE 513



CODE 3020

Finishing colours in print may differ from real ones.

Fabrics and finishings

Plastics

Ellie^{Pro}/ Trillo^{Pro}

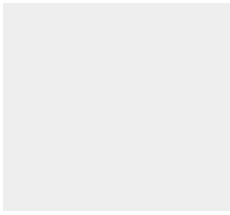

Light grey (RAL 7047)



Black

Plastics

Mickey

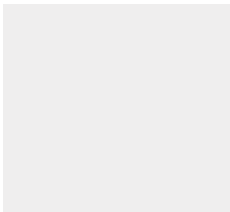

Light grey (RAL 7047)



Grey (RAL 7043)

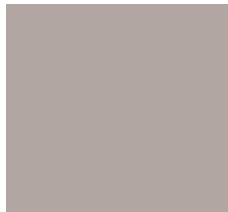

Beige (RAL 7036)

Plastics / frames

Zoo

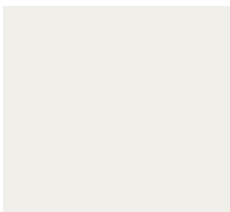

Light grey (NCS S 2500-N)



Grey (NCS S 6500-N)



Black (RAL 9005)

Fabrics and finishings

Tempered glass

Chic Tables



G1 (Milky)



G2 (Black)





























G3 (RAL 7044)



G4 (RAL 7042)

Legend

 20,0	net weight		Ergonomie geprüft
 22,5	gross weight		GS (geprüfte Sicherheit)
 10	stacking (max. quantity)		Quality Office
 15	stacking on trolley for transportation (max. quantity)		MöBELFAKTA
	right-sided table top		The Blue Angel
	left-sided table top	www.blauer-engel.de/uz117	
	joining in rows		Forest Stewardship Council®
	two-colour upholstery		Environmental Product Declarations (EPD)
	teflon glides		GS (Intertek)
	felt glides		EU Ecolabel: PL/049/001
	special threads		
	clothes hanger		
	Mediaport		
	guarantee period		
	ISO 9001		
	ISO 14001		
	Chrom (III)		
	The mark of responsible forestry. Concerns only products indicated as FSC® certified.		

Office

Flokk AB
Rosenlundsgatan 40,
trapphus B, vån 3
118 52 Stockholm
Sweden

Social Media

Facebook
YouTube
Instagram
Pinterest
LinkedIn

Factory

Flokk AB
Vallgatan 1
571 41 Nässjö
Sweden